

SELECT SEATING

*DIMENSIONS ARE APPROXIMATE

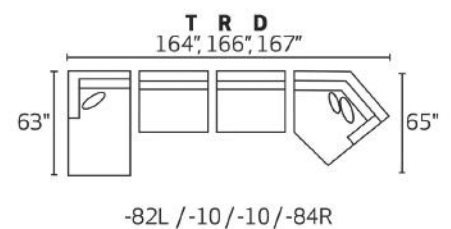
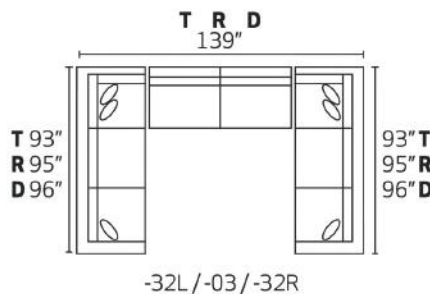
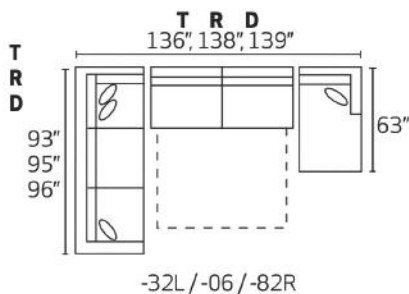
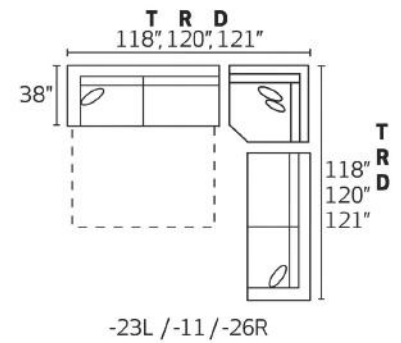
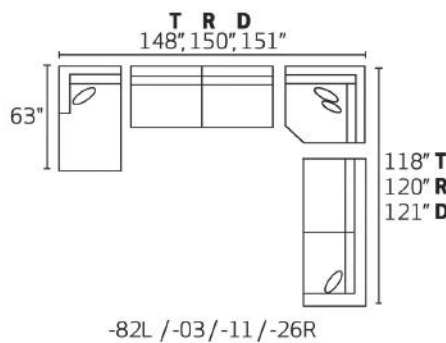
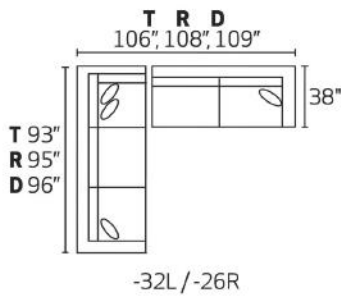
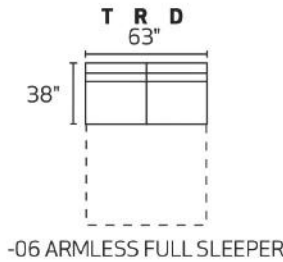
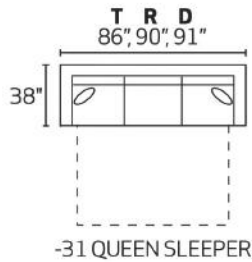
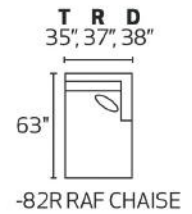
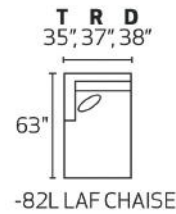
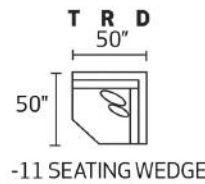
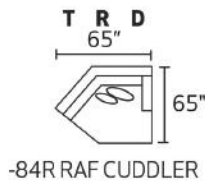
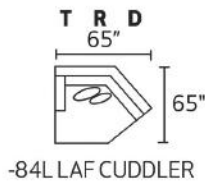
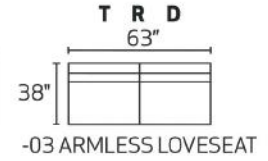
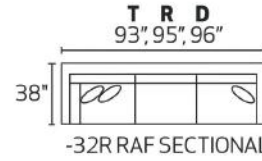
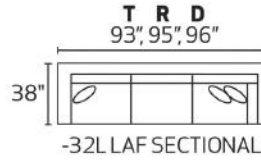
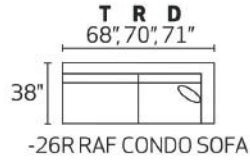
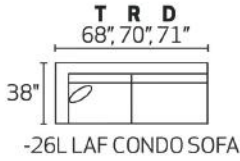
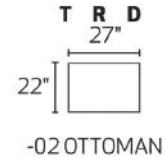
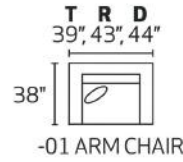
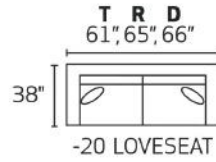
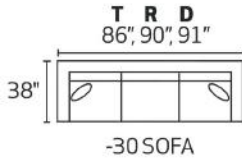

OPTIONS

STANDARD BACK

KNIFE EDGE BACK

UPHOLSTERED
BASE

WOOD
BASE

UPHOLSTERED
BASE

WOOD
BASE

TRACK
ARM

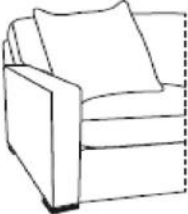

367
Gregory



577
Joshua



595
John



598
Jill

DOME
ARM



314
Rhodes



587
Jinger



596
Joy



599
Josie

ROLL
ARM



335
Fletcher



576
Jason



594
Jennifer



597
Jeremiah